

SEAFLO®

Make water work for you

**MARINE & RV
PRICELIST**

2023



CE RoHS ISO 9001:2015 ISO 8849 ISO8846 FDA  SGS



Welshpool Head Office
89 Pilbara Street
Welshpool WA 6106
Tel: +61 8 6163 3626
Fax: +61 8 6163 3630
sales@westatehose.com.au

O'Connor Branch
117 Garling St
O'Connor WA 6163
Tel: +61 8 9314 1833
Fax: +61 8 9314 1176
oconnor@westatehose.com.au

NON - AUTOMATIC BILGE PUMPS

Model	Flow Rate	Voltage	Head	Outlet Dia	Ctn Qty	List Price
SFBP1-G500-01	30.3L/M	12 V	3m	3/4" (19mm)	40	\$29.64

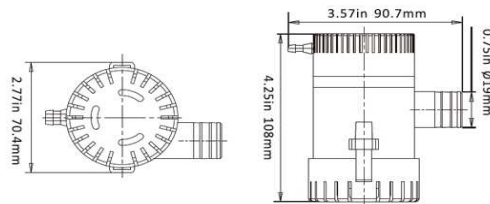

Model	Flow Rate	Voltage	Head	Outlet Dia	Ctn Qty	List Price
SFBP1-G750-01	45.4L/M	12 V	3m	3/4" (19mm)	40	\$37.66
SFBP2-G750-01	45.4L/M	24 V	3m	3/4" (19mm)	40	\$37.66

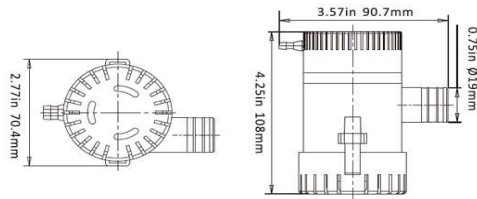

Model	Flow Rate	Voltage	Head	Outlet Dia	Ctn Qty	List Price
SFBP1-G1100-01	66.5L/M	12 V	4m	1 1/8" (28mm)	40	\$48.47
SFBP2-G1100-01	66.5L/M	24V	4m	1 1/8" (28mm)	40	\$48.47

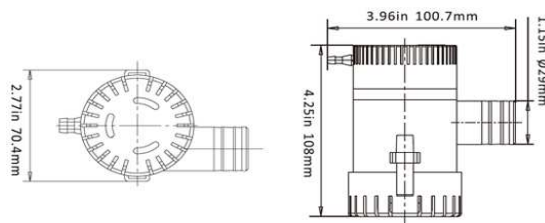

Model	Flow Rate	Voltage	Head	Outlet Dia	Ctn Qty	List Price
SFBP1-G3500-01	211 L/M	12V	7m	1 1/2" (40mm)	8	\$341.33

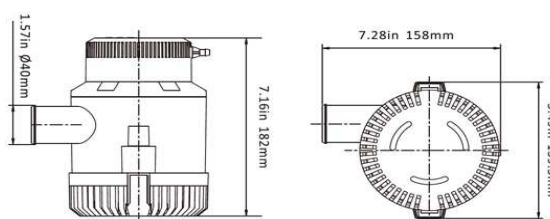

Model	Flow Rate	Voltage	Head	Outlet Dia	Ctn Qty	List Price
SFBP1-G4700-01	296.5L/M	12V	8m	2" (50mm)	8	\$369.15

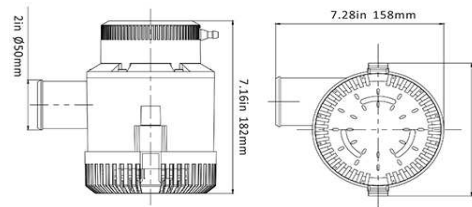

NON - AUTOMATIC BILGE PUMPS

Model	Flow Rate	Voltage	Head	Outlet Dia	Ctn Qty	List Price
SFBP1-G1500-01	90.8L/M	12 V	5m	1 1/8" (28mm)	16	\$115.03
SFBP2-G1500-01	90.8L/M	24 V	5m	1 1/8" (28mm)	16	\$115.03

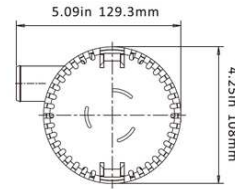
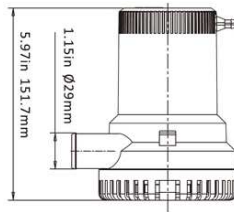

Model	Flow Rate	Voltage	Head	Outlet Dia	Ctn Qty	List Price
SFBP1-G2000-01	121L/M	12 V	8m	1 1/8" (28mm)	16	\$126.42
SFBP2-G2000-01	121L/M	24 V	8m	1 1/8" (28mm)	16	\$126.42

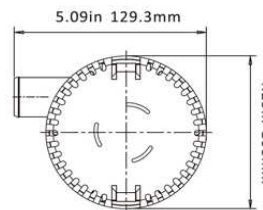
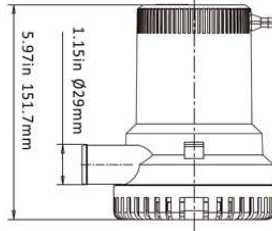

FLOAT SWITCH

Model	Wire Length	Voltage		Water Level	Ctn Qty	List Price
SFBS-20-01	1m	12 V & 24 V		2" (51mm)	48	\$49.86

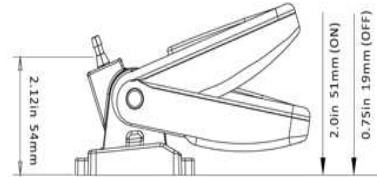
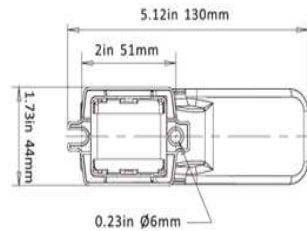

3 - WAY SWITCH

Model	Voltage	LED Light		Panel Material	Ctn Qty	List Price
SFSP-015-02	12 V & 24 V	YES		Aluminium	45	\$74.04

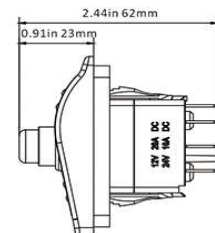
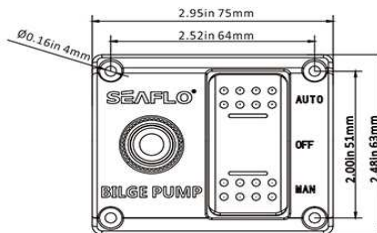

BATTERY ISOLATOR SWITCH

Model	Max Voltage	AMP Draw	Max AMP	Switch Positon	Ctn Qty	List Price
SFCBS-275-201	50 V	275A	1250A	2	45	\$36.38



AUTOMATIC BILGE PUMPS

Model	Flow Rate	Voltage	Head	Outlet Dia	Ctn Qty	List Price
SFBP1-G750-06	45.4 L/M	12 V	3m	3/4" (19mm)	20	\$91.48
SFBP2-G750-06	45.4 L/M	24 V	3m	3/4" (19mm)	20	\$91.48

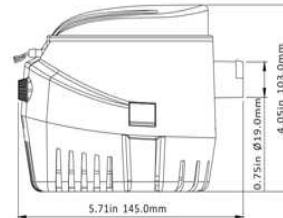
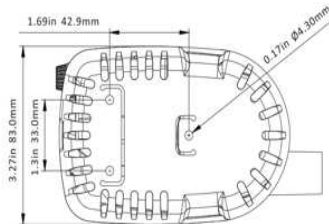

Model	Flow Rate	Voltage	Head	Outlet Dia	Ctn Qty	List Price
SFBP1-G1100-06	66.5 L/M	12 V	3m	1 1/8" (29mm)	20	\$103.68
SFBP2-G1100-06	66.5 L/M	24 V	3m	1 1/8" (29mm)	20	\$103.68

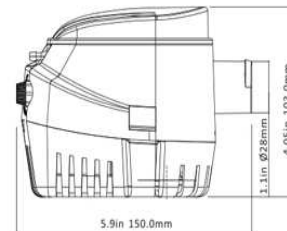
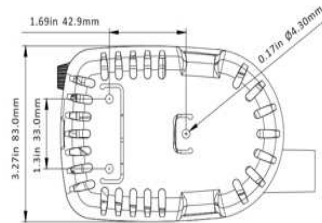

Model	Flow Rate	Voltage	Head	Outlet Dia	Ctn Qty	List Price
SFBP1-G1100-14A	66.5 L/M	12 V	4m	3/4"(19mm), 1" (25mm)	20	\$139.58
SFBP2-G1100-14A	66.5 L/M	24 V	4m	& 1 1/8" (29mm)	20	\$139.58

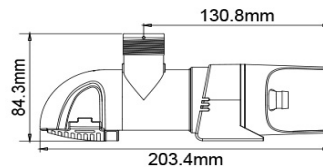
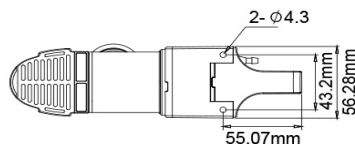

LIVE WELL PUMP

Model	Flow Rate	Voltage	Head	Outlet Dia	Ctn Qty	List Price
SFBP1-G800-04	61L/M	12 V	4m	3/4" (19mm)	20	\$56.55

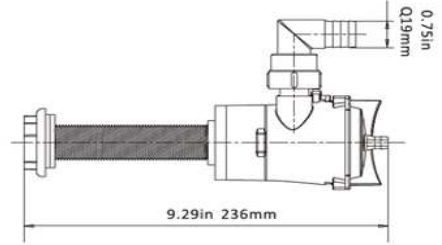
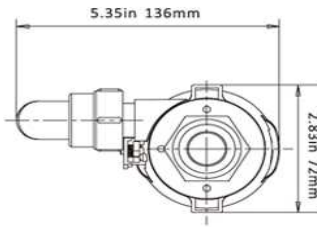

Model	Flow Rate	Voltage	Head	Outlet Dia	Ctn Qty	List Price
SFBP1-G800-05	61L/M	12 V	4m	3/4" (19mm)	20	\$56.55

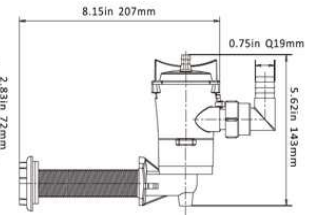
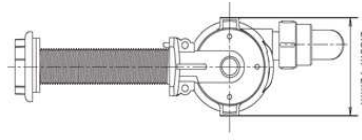

Model	Flow Rate	Voltage	Head	Outlet Dia	Ctn Qty	List Price
SFBP1-G350-10	20.25 L/M	12 V	1.2m	3/4" (19mm)	20	\$72.65

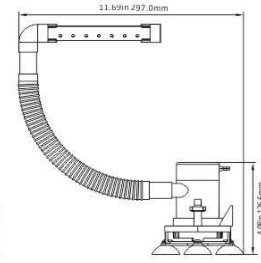

SEA WATER FILTERS

Model	Output Size	Hose Size	Recommended Input	Ctn Qty	List Price
SF-SWF002	12.7mm (1/2")	13mm	23L/min	40	\$41.30
	15.9mm (5/8")	16mm	35L/min		
	19.1mm (3/4")	19mm	51L/min		

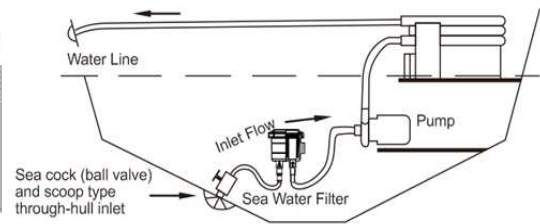
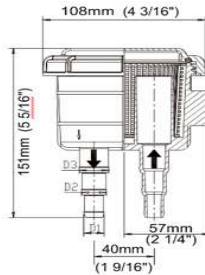

Model	Output Size	Hose Size	Recommended Input	Ctn Qty	List Price
SF-SWF001	25.4mm (1")	25mm	91L/min	24	\$91.65
	31.8mm (1-1/4")	32mm	143L/min		
	38.1mm (1-1/2")	38mm	200L/min		

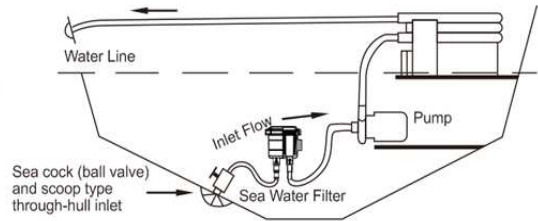
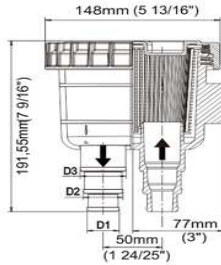

SUBMERSIBLE PUMPS

Model	Flow Rate	Voltage	Wire	Outlet Dia	Ctn Qty	List Price
SFSP1-G200-03	11.7L/M	12 V	1 m	1/2" (12mm)	20	\$58.15

Flow LPH	Head(M)
707	0
575	1
389	2
317	3
174	4
0	5

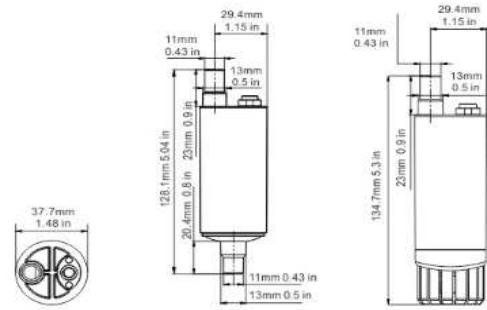

Model	Flow Rate	Voltage	Wire	Outlet Dia	Ctn Qty	List Price
SFSP1-G280-02A	17.6 L/M	12 V	5 m	1/2" (12mm)	15	\$113.69

Flow LPH	Head(M)
1006	0
855	1
662	2
503	3
408	4
249	5
0	6

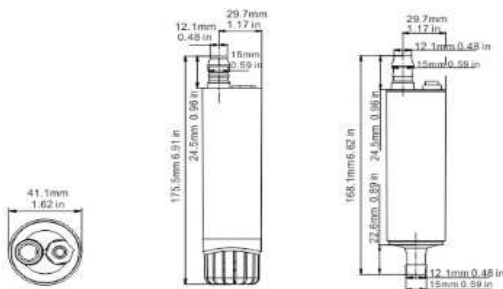

Model	Flow Rate	Voltage	Wire	Outlet Dia	Ctn Qty	List Price
SFSP1-G500-02A	31.0 L/M	12 V	5 m	3/4" (19mm)	15	\$145.41

Flow LPH	Head(M)
1862	0
1510	1
1434	2
1203	3
961	4
635	5
121	6
0	7

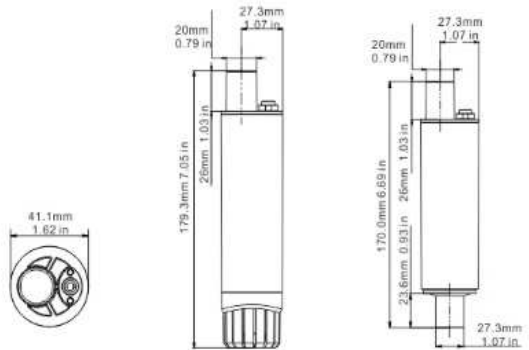

SUBMERSIBLE PUMPS

Model	Flow Rate	Voltage	Wire	Outlet Dia	Ctn Qty	List Price
SFSP1-L016-01	16L/M	12 V	3 m	1/2" (12mm)	90	\$48.47

Flow LPH	Head(M)
700	1
500	2
439	3
325	4
167	5
0	5.5

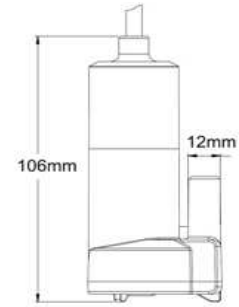
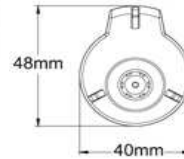

TRANSFER PUMP

Model	Flow Rate	Voltage	Ports	Ctn Qty	List Price
SFSP1-080-003-01	30L/M	12 V	1/2' NPT Female	8	\$289.22
SFSP2-080-003-02	30L/M	24 V	1/2' NPT Female	8	\$289.22

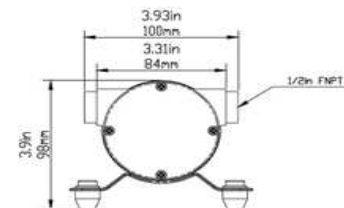
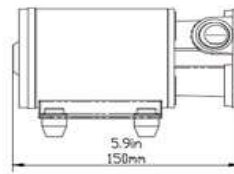
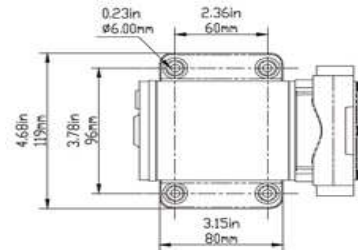

GEAR PUMP

Model	Flow Rate	Voltage	Ports	Ctn Qty	List Price
SFGP1-032-003-01	12L/M	12 V	1/2' NPT Female	8	\$289.22
SFGP2-032-003-01	12L/M	24 V	1/2' NPT Female	8	\$289.22

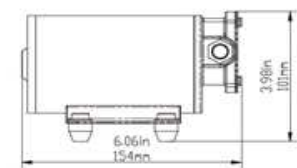
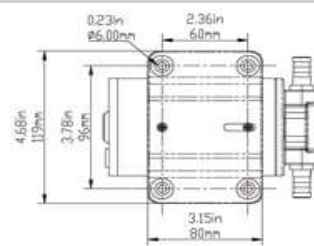
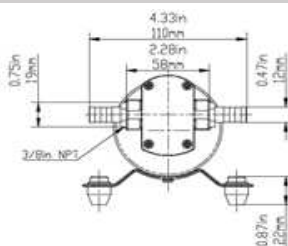

PISTON HAND PUMP

Model	Hose	Length	Suction Lift	Ctn Qty	List Price
SFPH-H950-01	1' (25mm)	.5 m	1 m	10	\$41.68

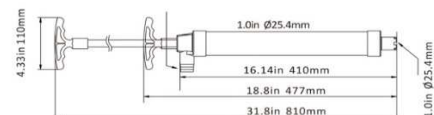

DIAPHRAGM PUMPS

Model	Voltage	Flow Rate	Shut Off Pressure PSI/Bar	Wire Connection	Ctn Qty	List Price
SFDP1-010-040-21	12 V	3.8L/M	40 / 2.8	2-Pin/Leads	30	\$63.24

Supplied with 3/8" & 1/2" Barbs

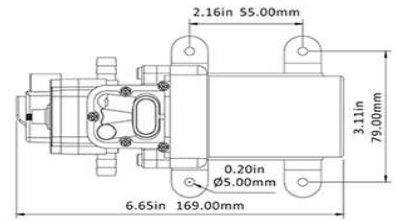
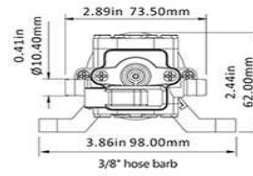
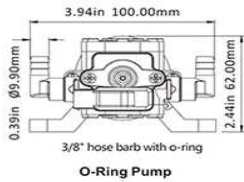

Model	Voltage	Flow Rate	Shut Off Pressure PSI/Bar	Wire Connection	Ctn Qty	List Price
SFDP1-012-040-23A	12 V	3.8 L/M	40 / 2.8	2-Pin/Leads	10	\$80.92

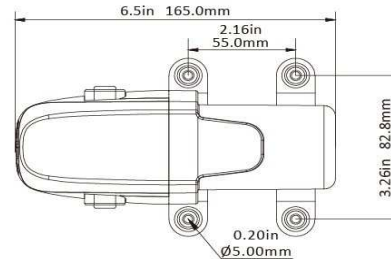
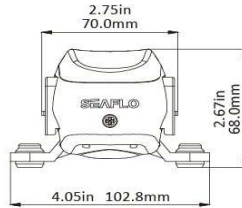

Model	Voltage	Flow Rate	Shut Off Pressure PSI/Bar	Wire Connection	Ctn Qty	List Price
SFDP1-013-100-22	12 V	5 L/M	100 / 6.9	2-Pin/Leads	18	\$113.42
SFDP2-013-100-22	24 V	5 L/M	100 / 6.9	2-Pin/Leads	18	\$113.42
SFDP1-013-060-22	12 V	5 L/M	60 / 4.2	2-Pin/Leads	18	\$113.42

Supplied with 3/8" & 1/2" Barbs

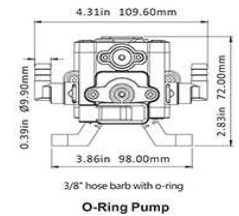
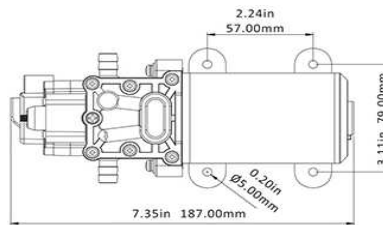
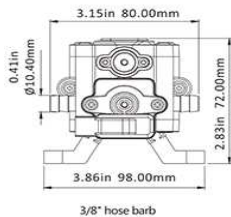

Model	Voltage	Flow Rate	Shut Off Pressure PSI/Bar	Wire Connection	Ctn Qty	List Price
SFDP1-030-045-33	12 V	11.6 L/M	45 / 3.1	2-Pin/Leads	8	\$170.61
SFDP2-030-045-33	24 V	11.6 L/M	45 / 3.1	2-Pin/Leads	8	\$170.61

Male NPT Ports

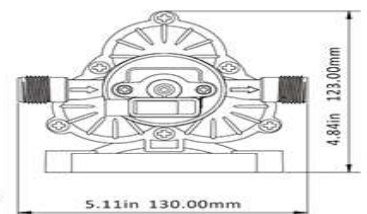
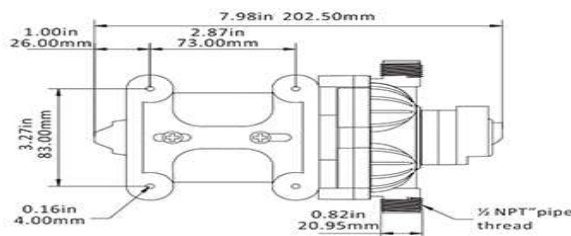

DIAPHRAGM PUMPS

Model	Voltage	Flow Rate	Shut Off Pressure PSI/Bar	Wire Connection	Ctn Qty	List Price
SFDP1-045-040-41	12 V	17 L/M	40 / 2.8	2-Pin/Leads	10	\$215.23
SFDP2-045-040-41	24 V	17 L/M	40 / 2.8	2-Pin/Leads	10	\$215.23

3/4" Quick Attach x 1/2" Hose Barb

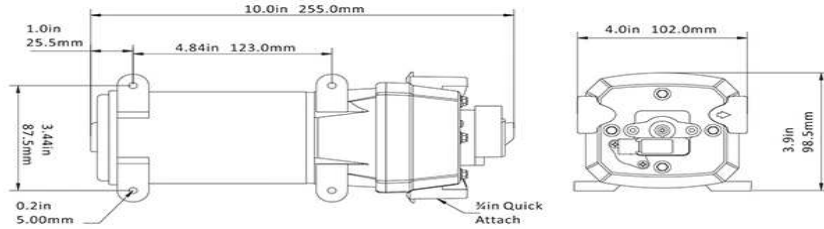

Model	Voltage	Flow Rate	Shut Off Pressure PSI/Bar	Wire Connection	Ctn Qty	List Price
RV1-030-055-42	12 V	9.5 L/M	55 / 3.8	2-Pin/Leads	8	\$201.69
RV2-030-055-42	24 V	9.5 L/M	55 / 3.8	2-Pin/Leads	8	\$201.69

1/2' Male NPT Ports

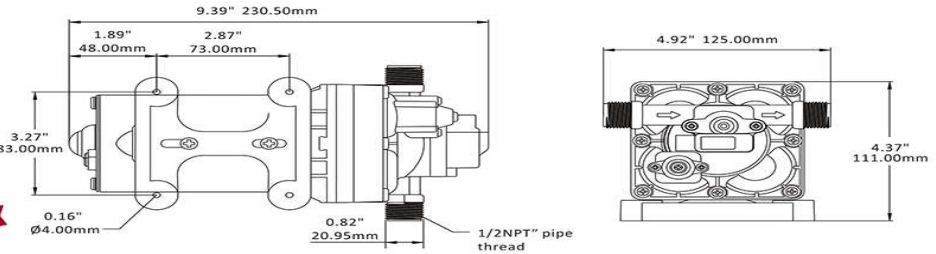

Model	Voltage	Flow Rate	Shut Off Pressure PSI/Bar	Wire Connection	Ctn Qty	List Price
SFDP1-050-070-51X	12 V	18.9 L/M	70 / 4.8	2-Pin/Leads	6	\$278.15
SFDP2-050-070-51X	24 V	18.9 L/M	70 / 4.8	2-Pin/Leads	6	\$278.15

1/2' Male NPT Ports

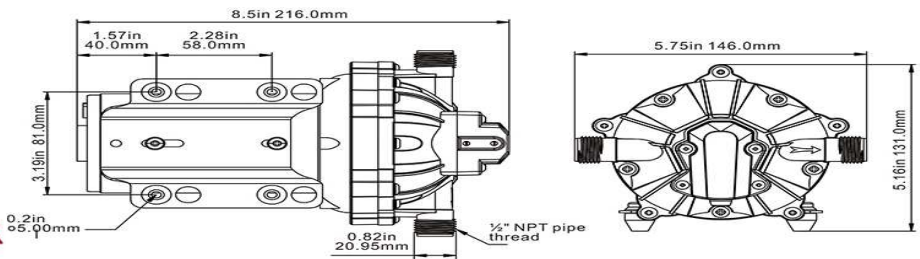

Model	Voltage	Flow Rate	Shut Off Pressure PSI/Bar	Wire Connection	Ctn Qty	List Price
SFDP1-070-060-53	12 V	26.5 L/M	60 / 4.2	2-Pin/Leads	4	\$514.56

3/4" Quick Attach x 1/2" Hose Barb

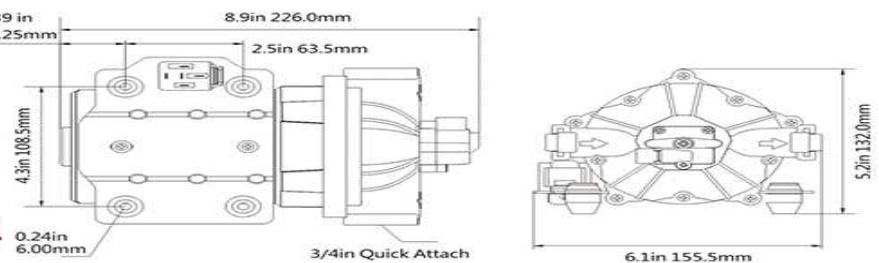

PRESSURE ACCUMUATOR

Model	Volume	Max Operating	Pre-Charge PSI/Bar	Inlet / Outlet	Ctn Qty	List Price
SFAT-075-125-01	.75 L	8.6 L/M	10 / 0.7	1/2" NPT Male	24	\$80.73

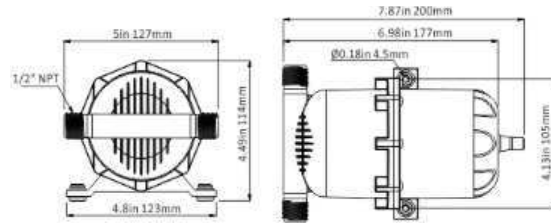

SFAT-075-125-01 0.75 L

PUMP ACCUMUATOR PRESSURE BOOST SYSTEM

Model	Tank Volume	Voltage	Control Type	Open Flow (LPM)	Pressure On PSI/BAR	Pressure Off PSI / BAR	List Price
SFWSK1-030-060-021	8L	12V	Switch	11.5 L/M	20 / 1.4	60 / 4.2	\$477.31
SFWSK1-050-060-021	8L	12V	Switch	18.9 L/M	20 / 1.4	60 / 4.2	\$477.31

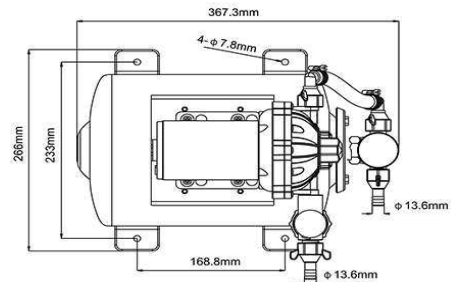
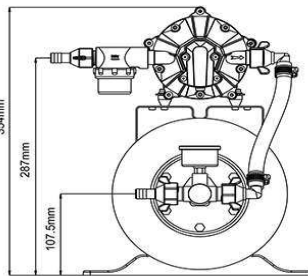

FEATURES & BENEFITS

Five Chamber diaphragms for smooth and quiet operation

High quality TTI micro pressure switch

Self-priming up to 6 feet (1.8 m)

NPT Connector, better seal

Complies with USCG 183.410 and ISO 8846 MARINE (Ignition Protection)

Lower batter drain, quiet operation, long pump life

Can be installed vertically or horizontally

FEATURES & BENEFITS

- Smoother flow, quieter water systems.
- Maintenance free potable water quality accumulator tank.
- Five chamber diaphragms for smooth and quiet operation.



WASHDOWN

Model	Voltage	Flow Rate	Shut Off Pressure PSI/Bar	Wire Connection	Ctn Qty	List Price
SFWP1-050-070-51X	12 V	18.9 L/M	70 / 4.8	2-Pin/Leads	4	\$361.34
SFWP2-050-070-51X	24 V	18.9 L/M	70 / 4.8	2-Pin/Leads	4	\$361.34

Includes

18.9LPM Heavy Duty Washdown Pump
Trigger spray nozzle w/ Quick Connect

7.5m UV-protected coiled hose
Quick Hose disconnect fitting

Inlet Strainer
1/2' Barbed Fittings



Model	Voltage	Flow Rate	Shut Off Pressure PSI/Bar	Wire Connection	Ctn Qty	List Price
SFWP1-045-070-41	12 V	17 L/M	70 / 4.8	2-Pin/Leads	3	\$369.85

Features & Benefits

6m UV-Protected coiled hose
2m Inlet hose with filter

Cigarette Lighter Plug in
Adjustable Spray

Easy to use, store and carry on
Smooth Flowing



Model	Ctn Qty	List Price
SFHW2-060-01	8	\$67.30

Includes

6m x 1/2" UV-Protected coiled hose

Trigger spray nozzle w/ Quick Connect fittings



PUMP ACCESSORIES



51F01



51F02



51F03



51F04



51F05



21F001 + 21F002



41F001



41F002



41F003



41F004



51S01



**PS35, PS40, PS45, PS55
PS70**



SFRB-RV-MOUNT



SFRB-33-MOUNT



SFRB-51X-MOUNT

Code	Description	List Price
SF-51F01	51 Series 1/2" NPT F x 1/2" Hose Barb	\$5.88
SF-51F02	51 Series 1/2" NPT F x 3/8" Hose Barb	\$5.88
SF-51F03	51 Series 1/2" NPT F x 1/2" Hose Barb 90°	\$5.88
SF-51F04	51 Series 1/2" NPT F x 1/2" NPT Elbow 90°	\$5.88
SF-51F05	51 Series 1/2" NPT F x 3/8" Hose Barb 90°	\$5.88
SF-21F001	21-22 Series 90° 3/8"	\$1.71
SF-21F002	21-22 Series 90° 1/2"	\$1.71
SF-41F001	41 Series QA x 90° x 1/2" Elbow	\$5.88
SF-41F002	41 Series QA x 90° x 1/2" NPT Elbow	\$5.88
SF-41F003	41 Series QA x 1/2" Hose Barb	\$5.88
SF-41F004	41 Series QA x 1/2" NPT	\$5.88
SF-51S01	51 Series 1/2" NPT M & F Inline Filter	\$20.17
SFPS35	Pressure Switch 35PSI 20 Amp	\$22.79
SFPS40	Pressure Switch 40PSI 20 Amp	\$22.79
SFPS45	Pressure Switch 45PSI 20 Amp	\$22.79
SFPS55	Pressure Switch 55PSI 20 Amp	\$28.31
SFPS70X	Pressure Switch 70PSI 20 Amp	\$28.31
SFRB-RV-MOUNT	Thermoplastic Base to suit RV Supreme	\$26.03
SFRB-33-MOUNT	Metal Base to suit 33 Series pump	\$26.03
SFRB-51X-MOUNT	Metal Base to suit 51X Series pump	\$26.03

SHOWER SUMP

Model	Voltage	Flow Rate	Head	Outlet	Wire Lead	Ctn Qty	List Price
SFBP1-G750-07	12 V	47.3 L/M	3 m	3/4" (19mm)	1 m	9	\$162.75
SFBP2-G750-07	24V	47.3 L/M	3 m	3/4" (19mm)	1 m	9	\$162.75

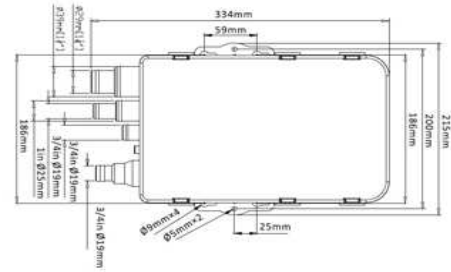
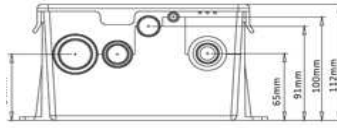

MACERATOR PUMP

Model	Voltage	Flow Rate		Outlet	Inlet	Ctn Qty	List Price
SFMP1-120-01	12 V	45 L/M		1" Barb	1 1/2" MNPT	10	261.56

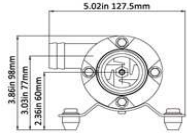
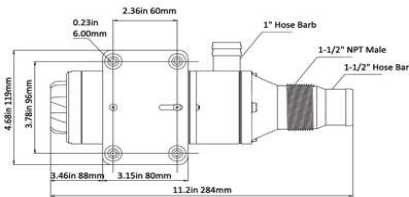

TOILET

Model	Voltage	Size	Outlet	Inlet	Ctn Qty	List Price
SFMT1-01-R	12 V	Household	1" Barb	3/4" (19mm)	1	\$610.60
SFMT2-01-R	24 V	Household	1" Barb	3/4" (19mm)	1	\$610.60

Features

- Built In Macerator
- Electric Impeller
- Ceramic Bowl
- Soft Close Seat

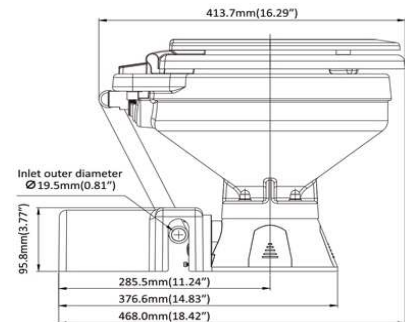
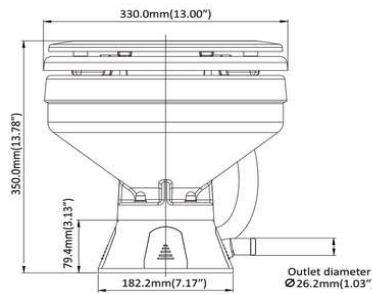

HATCHES

Model	Size inch	ID (mm)	OD (mm)	Color	Ctn Qty	List Price
SFRH1-004-01	4"	101	143	White	80	\$17.01
SFRH1-006-01	6"	151	198	White	40	\$25.14
SFRH1-008-01	8"	180	250	White	40	\$37.66

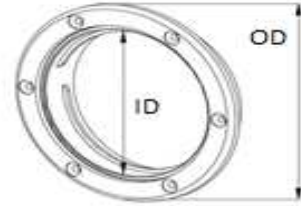

Model	Door Height (H) (mm)	Door Width (L) (mm)	Hatch Height (H1) (mm)	Hatch Width (L1) (mm)	Ctn Qty	List Price
SFRE1-243-607-01	243	607	168	525	10	\$123.75
SFRE1-315-440-01	315	440	240	358	10	\$111.44
SFRE1-353-606-01	353	606	278	524	10	\$153.49
SFRE1-370-375-01	370	375	295	295	10	\$112.08
SFRE1-460-510-01	460	510	383	436	10	\$152.47

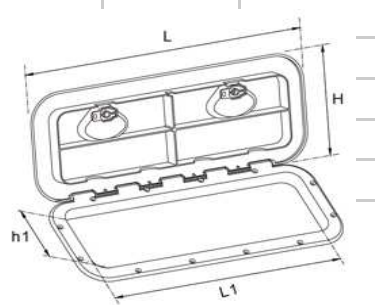

Model	Door Height (H) (mm)	Door Width (L) (mm)	Hatch Height (H1) (mm)	Hatch Width (L1) (mm)	Ctn Qty	List Price
SFRE1-270-375-01	270	375	192	291	10	\$89.67

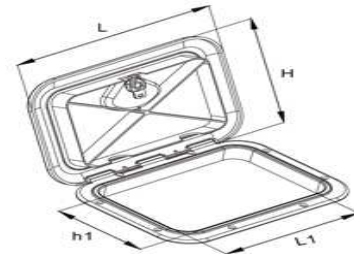

Reading A Serial Number

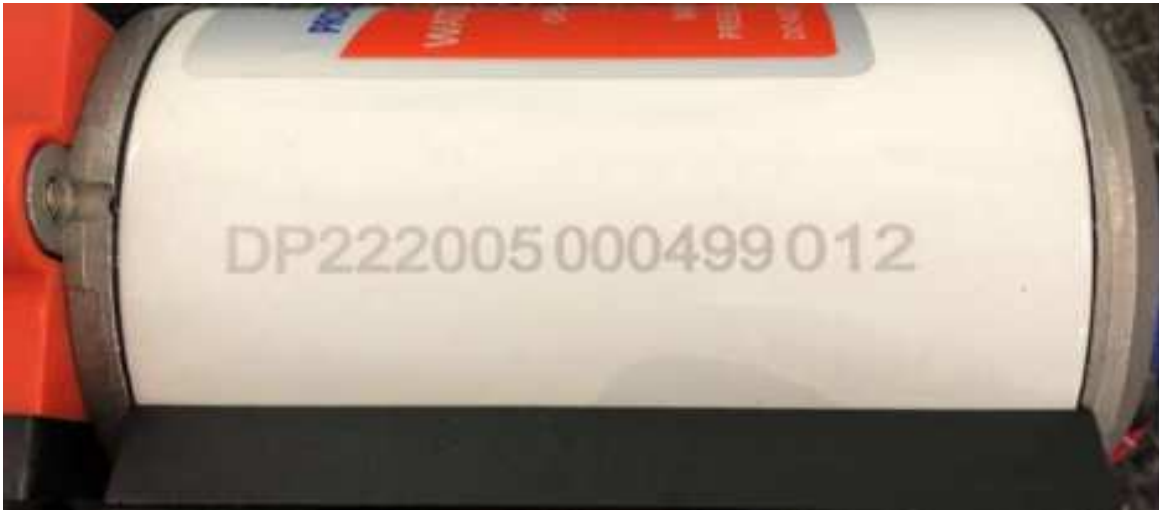

DP22 2005 000499 012			
Section 1	Section 2	Section3	Section 4

Section 1.

Type of pump and Model. (Diaphragm Pump Model-22 series)

Section 2.

Year and month of manufacture (2005 = 2020/05 May)

Section 3.

Number in production Batch (No. 000499)

Section 4.

Voltage (12Volt 012)

Trouble Shooting Guide

1. Pump will not start or blows the circuit

*The first thing would be to look at the electrical circuit. This includes checking the fuse, switch, circuit breaker, and the earth. If you are running off batteries, make sure you are obtaining correct voltage.

*Check to see if the pump is hot. It could simply have stopped due to the thermal breaker being triggered. Wait until it cools down.

*If your pump has spent the night in below freezing conditions such as those experienced in some parts of alpine Australia, it could be that the water against the pump diaphragm has frozen causing it to seize. Wait for it to thaw.

*If you have voltage present at the switch, try bypassing the pressure switch. Does the pump operate?

*Check your pump is getting correct voltage.

2. Pump runs but will not prime and splutters

*Check the water level of your tank. It is not as silly as it sounds.

*It is common that the strainer or inline filter has become clogged with foreign debris. If this happens it will stop the flow of water to the pump. Simply clean or replace the filter

If you are using a hot water system, air could have built up within your hot water tank producing an air lock. Release the pressure from your tank, refer to your HWS owner's manual.

*Check your plumbing connections. If they have become loose, they could very well be causing a vacuum leak.

*Check your hose to make sure no kinks have appeared, and that all your valves are functioning correctly.

3. Pump rapid cycles

*The major cause of rapid cycling is restrictive plumbing. This can be restrictive taps and shower heads or kinked hoses.

*If you are running a water filter or purifier then this should be installed on a separate line feed. Do not purify all your water.

4. My pump will not shut off or runs when taps are closed

*Check your plumbing's pressured side for leaks, dripping taps, or if you have a plumbed

*Check your pump is receiving the correct voltage.

*Check the pump head screws have not worked loose.

*Possible debris is causing valves to stay open.

5. Pump is noisy or running rough

*Check plumbing has not worked loose or become kinked

*Clean out your strainer from any foreign debris.

*Is your pump plumbed using flexible hose and mounted correctly?

*Bleed your plumbing system of any air.

